

Super Slim Flush Mount Series



FDFM-10W-LED

4" 10W Round Super Slim Flush Mount with socket adaptor and spring

Factory Direct Lighting

100 Shields Court, Markham,
ON Canada L3R 9T5
Tel: 905-944-1210 • 1-855-533-0743 |
Toll Fax: 1-855-533-3294
<https://www.fdlighting.ca/>

Features

Body

Durable airtight aluminum body with etched white polycarbonate diffuser lens for low glare.

LED Characteristics

This general application light fixture features a 10 watt LED module that maintains uniform intensity producing up to 600 lumens ;with a typical CRI of 80 and a 50,000 hour life span .Available in 3000K or 4000K color temperature

Dimming

100%-10% dimming capability .This fixture is compatible with industry standard TRIC/ELV dimmers (contact factory for listing of compatible dimmers).

Beam Spred

The fixture lens provides 120° beam spread.

LED Driver

Internal LED Driver

Operating Temperature

-20°C~40°C

Environment

Suitable for wet locations.
Suitable for insulated ceiling applications.

SPECIFICATION

Application	Ceiling Mount
Approved Location	Wet
Beam Angle	120°
CCT	3000° K / 4000° K
Certifi cation	cETLus
Class II	Yes
Colour	BK / BN / WH
CRI	80
Dimming	Yes
Dimming Tech	TRIAC/ELV
Input	100-135V AC, 60Hz, 0.11A
LM79	Yes
LM80	Yes
Lumens	600Lm
Lumens per Watt	60
Power Factor	>0.9
Projected Life	70% @ 50,000 hrs
Warranty	5 Year
Wattage	10W

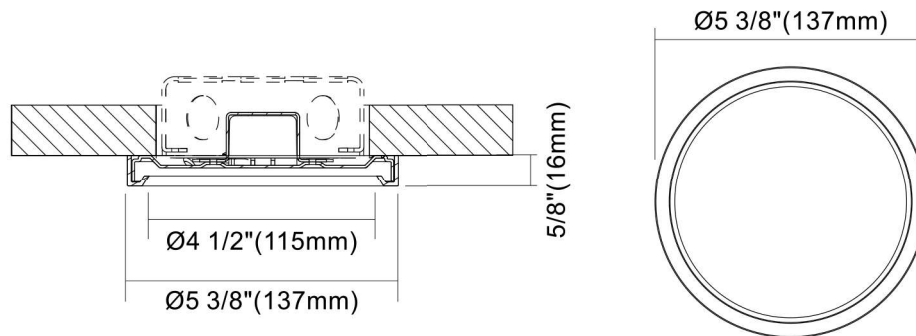

Ordering Guide

FDFM-10W-LED-3K-120V-D
FDFM-10W-LED-4K-120V-D



Socket adaptor and spring