

Installation manual
A.T-Grid ceilings installation

Step 1

Black, White, and Green wires

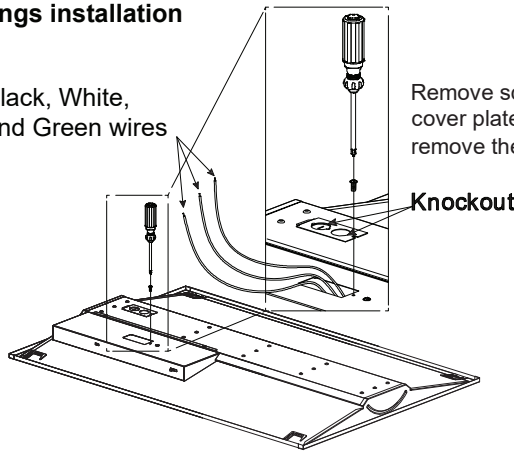

Step 2

Bend suspension tabs as shown

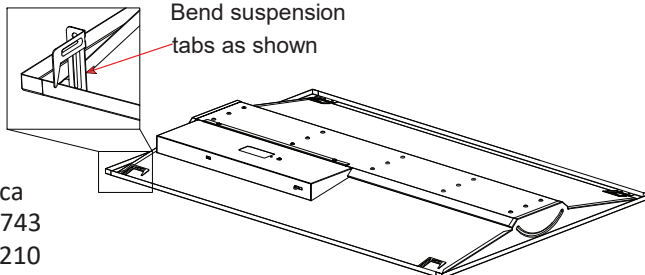

Step 4

Set light fixture into the suspension with tabs. Hang over the T-bar as shown.

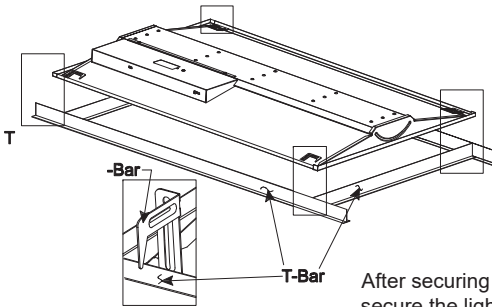

Step 3

Remove the ceiling tiles at an appropriate location where the light fixture is to be installed.

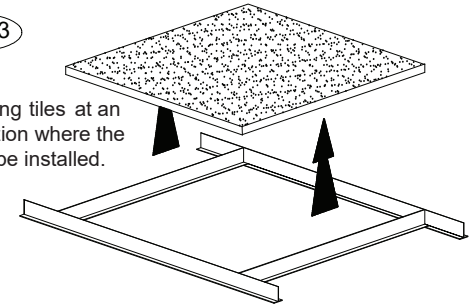

Step 5

After securing the light fixture to the T-bar, secure the light fixture to the ceiling with safety cable or wires capable of supporting 100 lbs. minimum (not included)

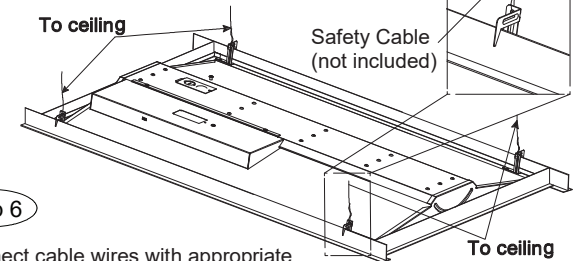

Step 6

Connect cable wires with appropriate relief strain and wire connectors (not included). Make sure all wires are tucked in before reinstalling the cover plate.

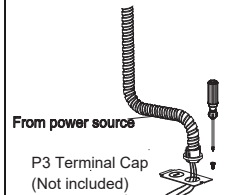

Step 7

Reinstall the cover plate.

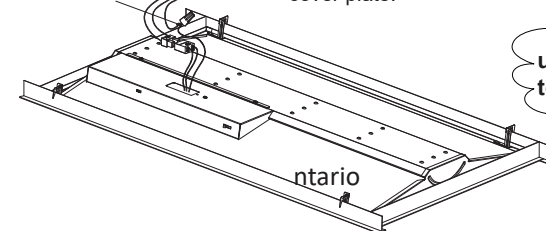

use wire disconnecter to cover unused wires