

Installation Instruction Smart Ceiling Light RGB and Tunable White



INSTRUCTIONS PERTAINING TO RISK OF FIRE OR INJURY TO PERSONS
READ ALL INSTRUCTIONS

IMPORTANT SAFETY INSTRUCTIONS

SAVE THESE INSTRUCTIONS

TOOLS AND MATERIALS REQUIRED:



Wiring supplies as required by the Canadian Electrical Code and/or the Quebec Electrical code

SAFETY PRECAUTIONS:

1. TURN OFF ELECTRICAL POWER BEFORE STARTING INSTALLATION OF LIGHT FIXTURE.
2. THIS PRODUCT MUST BE INSTALLED IN ACCORDANCE WITH THE APPLICABLE INSTALLATION CODE BY A PERSON FAMILIAR WITH THE CONSTRUCTION AND OPERATION OF THE PRODUCT AND THE HAZARDS INVOLVED.
3. CAUTION RISK OF FIRE . CONSULT A QUALIFIED ELECTRICIAN TO ENSURE CORRECT BRANCH CIRCUIT CONDUCTOR.
4. FOR EXETEMAL USE ONLY,RECOMMEND APPLYING WATERPROOF SILICONE TO SEAL AROUND TRIM AND CEILING.

PACKAGE CONTENTS

PART	DESCRIPTION	QTY	NOTE
A	LED Low Profile Flushmount	1	
B	Mounting screws	2	
C	Wire nut	3	Other
D	Mounting plate	1	

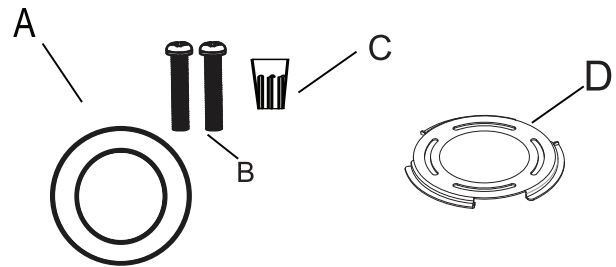

Option #1: FLUSH MOUNT

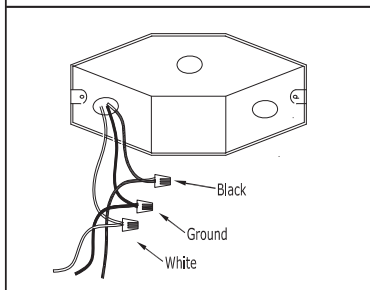
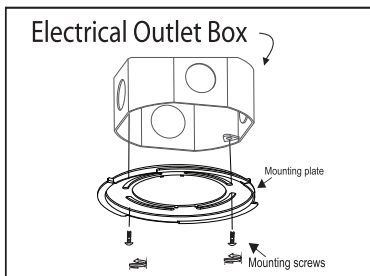

1. Prior to installation, install mounting plate into the electrical outlet box with mounting screws. Drive screws completely to the end of the junction box.
2. Connect supply wires to wires on fixture with wire nuts or push wires into Quick Connector. Connect white to white, black to black, and ground wire to ground wire as grounding connection.

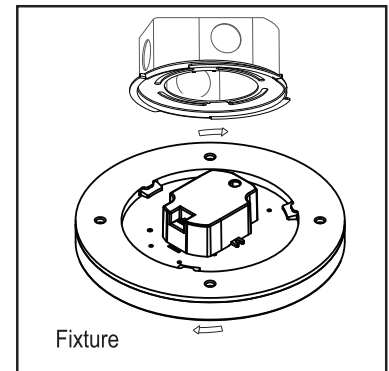

3. Completing the installation by pushing the fixture into the mounting plate

Quick Setup Guide

Downloading the Smart life App

Before you start, make sure you install the smart life App from either **Google Play** or the **Apple App Store** (both offer the same set of features). The app can also scale to fit tablets as needed.

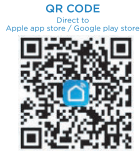

Installing and pairing luminaire

The luminaire is connected through the app and will only operate on your home's 2.4GHz Wi-Fi network. Most new routers are dual-bandwidth (both 2.4GHz and 5GHz), ensure you select the 2.4GHz network which covers a wider range than the 5GHz. To make sure your phone is on the 2.4GHz network, either select it in the list of available networks on your phone or go into the router settings and temporarily de-activate the 5GHz network (you can activate it again after pairing is done).

If this is not possible and the luminaire is not found, try putting the luminaire in pairing mode by cycling the power at the switch 5 times (ON/OFF), then walking a short distance away from the router. Due to the short range of 5GHz networks, your phone should auto-connect to the 2.4GHz at this point. Once connected, you can start pairing in the app. You can pair as many devices as you want at the same time.

1. Open the Smart Life app. On the Home page, tap the plus sign (+) in the upper right corner to Add Device.
2. On the Add Manually tab page, select Lighting and tap Light Source(BLE + Wi-Fi).Select upper right corner " EZ Mode".
- 1) Make sure light is rapidly flashing white. If not , reset to reach Easy Mode to connect. Tap " Next " in the App.
(Turn the device on , off . on . off and on until the indicator blinks or breathes.)

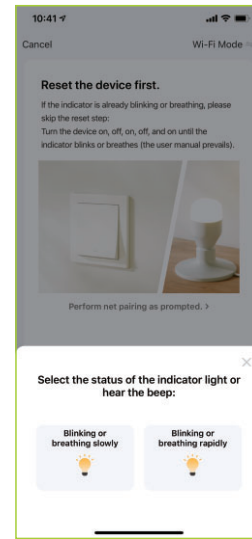
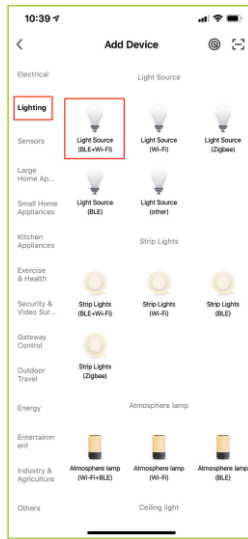
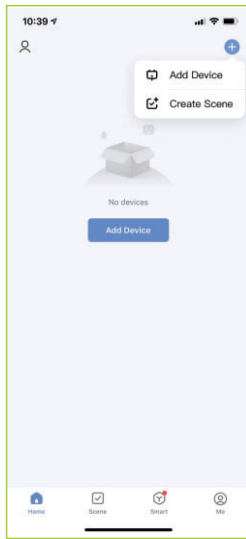

- 1) When the indicator blinks slowly, tap Confirm indicator slowly or rapidly blink to select the 2.4 GHz network.
 - 2) Connect your Wi-Fi network and enter password.
 - 3) The App will connect to your devices.
- Note: Only 2.4 GHz networks are supported.

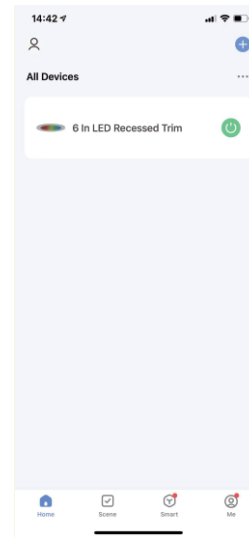
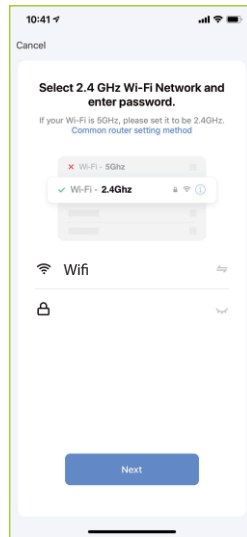
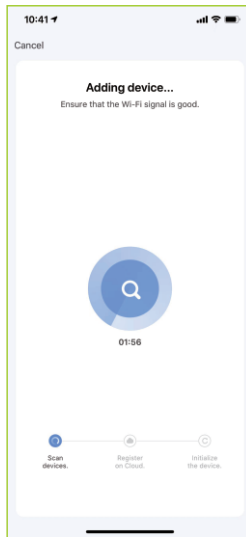

3. You can then view the bound lights on the Home page

1. What you need to get started

Before using Echo to control your smart devices, make sure you meet the following conditions :

- 1) Stable Wi-Fi network which could access to Amazon server.
- 2) An Echo device, including Echo, Echo Tap, or Echo Dot.
- 3) An Amazon account.
- 4) Smart Life app and a related account.
- 5) Make sure that one or more devices are bound to your account, and that the device name must be an English name that echo can easily recognize (such as bedroom light).

2. Set up Echo with Alexa app

3. Link Smart Life account to Alexa

1) Tap "Skills&Games" in the hamburger menu, then search "Smart Life". Select "Smart Life" and tap "ENABLE" to enable the Skill.

2) Then tap "Link Now" to link your Smart Life account.

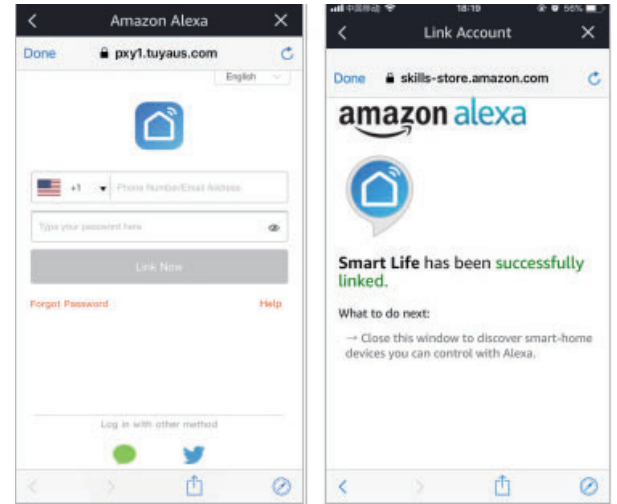
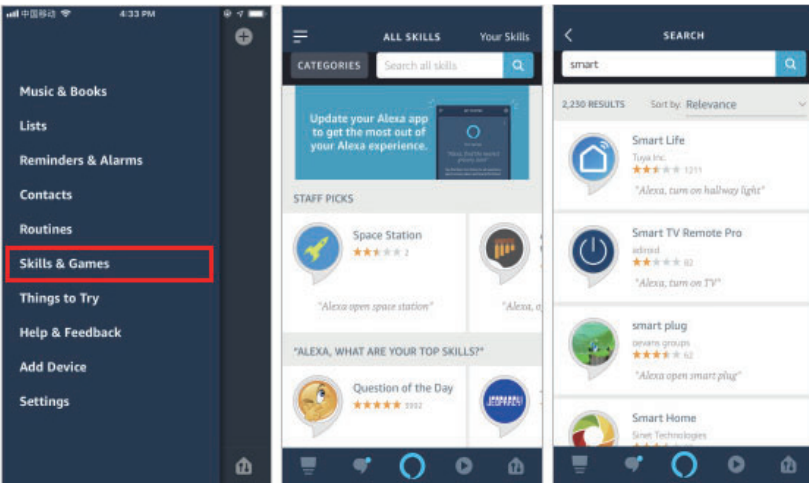

4. Control your smart devices through Echo

1) you can say "Alexa, discover devices" to Echo. Echo will discover devices which have already been added in the Smart Life app. Discovered devices will be shown in the list.

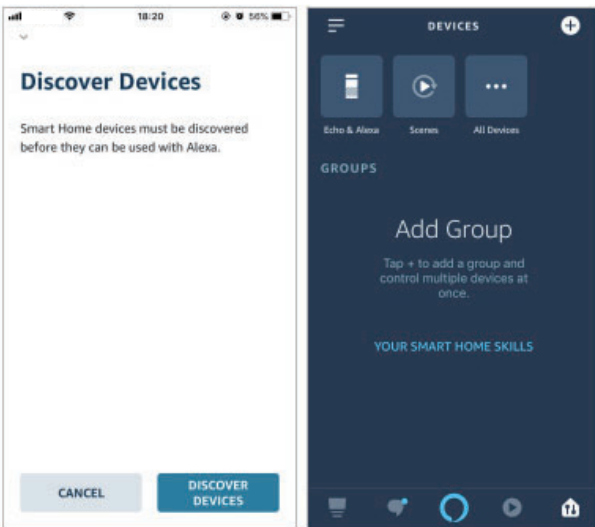

2) Control devices by voice commands

Now you can control your smart devices through Echo. You can use the following commands to control your devices (e.g., bedroom light):

- Alexa, turn on/off bedroom light.
- Alexa, set bedroom light to 50 percent.
- Alexa, brighten/dim bedroom light.
- Alexa, set bedroom light to green.
- Alexa, set bedroom light to warm white.