

# D-Series UFO Microwave Sensor

## 1. Features



- 12Vdc±1V input, for DC systems or LED power supplies with 12Vdc±1V auxiliary power output
- 0-10V dimming port, 3 or 2 step dimming function
- Newly patent design sensor antenna with two detection mode: high sensitivity detection and interference immunity detection. (suitable for installation environments with many metal reflective surfaces)
- Compact design, special for industrial lamps, sensors can be fixed at the edge or center of UFO.
- 15m maximum installation height, suitable for most warehouses
- Patented remote control, transmitting angle of the remote control is adjustable according to mounting height
- Dim+/Dim- to set occupancy light level
- Daylight priority function
- 5 years warranty

## 2. Parameter

<b>Input</b>	Operating Voltage Range	N/A
	DC Input Voltage	12Vdc±1V
	Rated Voltage	12Vdc±1V
	No-load Power	N/A
	Stand-by Power	<0.3W
	Surge Test	N/A
	Wiring	fast connector
<b>Output</b>	Working Mode	0-10V DC
	Type of Load	N/A
	Load Capacity	N/A
	Current of Load	N/A
	Wiring	fast connector
<b>Dim Interface</b>	0-10V Dimming	< 50mA (Non-constant source)
	Synchronous Control	N/A
	High Low-level	N/A
	PWM Control	N/A
<b>Sensor Parameters</b>	Operating Frequency	5.8 GHz ±75 MHz, ISM Band.
	Transmitting power	1mW Max.

	Hold time	5S/30S/1min/3min/5min/10min/20min/30min
	Stand-by DIM Level	10%(1.4-1.6V), 20%(1.9-2.1V), 30%(2.9-3.1V), 50% (4.9-5.1V)
	Stand-by Period	0s/10S/1min/3min/5min/10min/30min/+∞
	Detection Area	25%/50%/75%/100%
	Daylight Sensor	5lux/15Lux/30Lux/50Lux/100lux/150lux/Disable Daylight priority(5lux/15Lux/30Lux/50Lux)/150Lux 100Lux/200Lux 150Lux/300Lux
	Detecting Radius	See detection pattern
	Mounting Height	15m Max
	Detecting Angle	150°(wall mounting) 360°(ceiling mounting)
<b>Wireless Module</b>	Operating Frequency	N/A
	Transmitting power	N/A
	Transmitting distance	N/A
	Modulation mode	N/A
	Number of coding	N/A
<b>Operating Environment</b>	Operating Temperature	-35°C...+70°C
	Storage Temperature	Temperature: -40°C...+80°C; Humidity: 10%-95% (non-condensing)
<b>Certificate Standards</b>	Safety standards	EN60669-2-1, EN60669-1
	EMC standards	EN55015, EN61000-3-2, EN61000-3-3, EN61547
	Environmental Requirement	Compliant to RoHS
	Certificate	CE
<b>Others</b>	Wiring	UL21996,3*22AWG, cable length: 300mm(pending)
	IP Rating	IP20
	Protection Class	Class II
	Installation	External mounting,integrated mounting
	Dimension	See dimension
	Package	White paper box
	Net Weight	55g
	Lifetime	5 years warranty @Ta 230V full load
<p>Note</p> <p>1. "N/A"means not available.</p> <p>2. Detection area is effected on volume of motion object and motion speed. The detection area is tested by a 165cm height person and walking speed is 0.5m/s.</p>		

### 3.Function

1) On/OFF Function (stand-by period be set to "0"s)

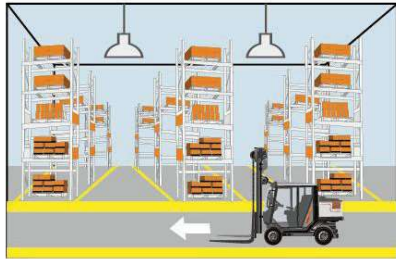

1 With sufficient ambient light, the light will not be switched on even if with motion signal.

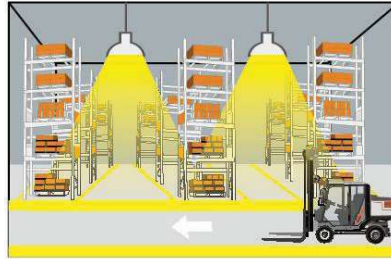

2 With insufficient ambient light, the sensor switches on the light when motion is detected.

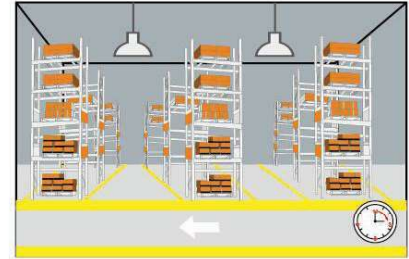

3 After elapse of hold time, the sensor switches off the light when no motion is detected.

2) 2-step dimming function (stand-by period be set to "+∞")

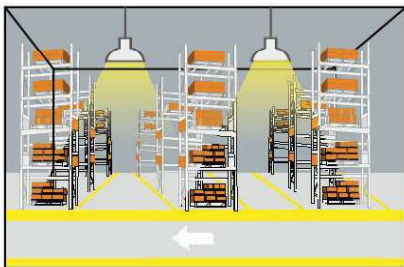

1 If there is no motion detected, the light will be remained at a low light level all the time.

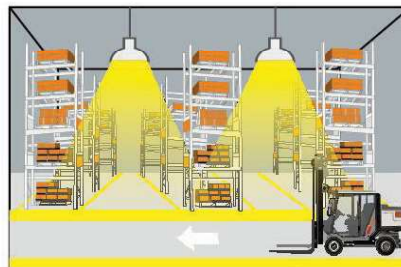

2 When motion is detected, the sensor will switch on the light to 100% brightness

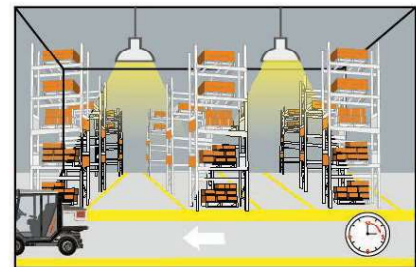

3 After elapse of hold time, the sensor dims the light at the present low light level if no motion is detected.

3) 3-step dimming function (stand-by period be set to "10S/1min/3min/5min/10min/30min")

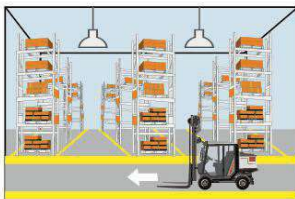

1 With sufficient ambient light, the light will not be switched on even if with motion signal.

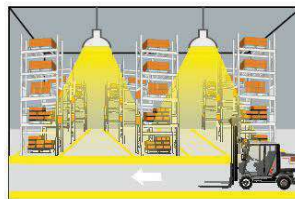

2 With insufficient ambient light, the sensor switches on the light when motion is detected.

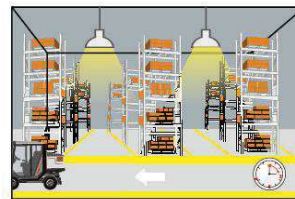

3 After elapse of hold time, the sensor dims the light at a low light level if no new motion is detected.

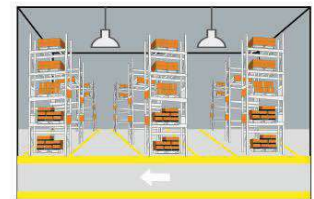

4 After elapse of standby period, the sensor switches off the light if no motion is detected in the detection zone.

4) Daylight priority (stand-by period set to  $+\infty$ )

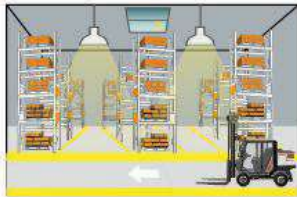

1 Lamp turns on at low light level 10% in the night.

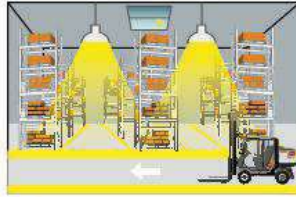

2 Motion detected, lamp automatically lights up to 100%.

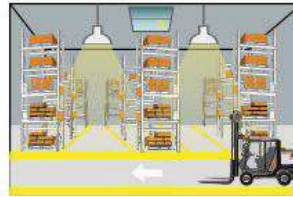

3 After hold time, the lamp gradually dims to a low light level 10% if no movement detected.

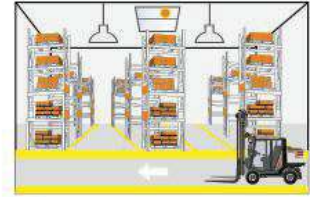

4 Lamp turns off after dawn.

4.Dimension (mm)

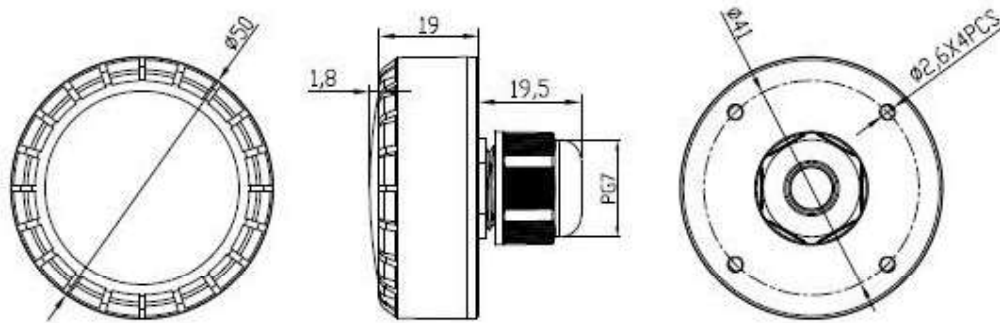

5. Wiring

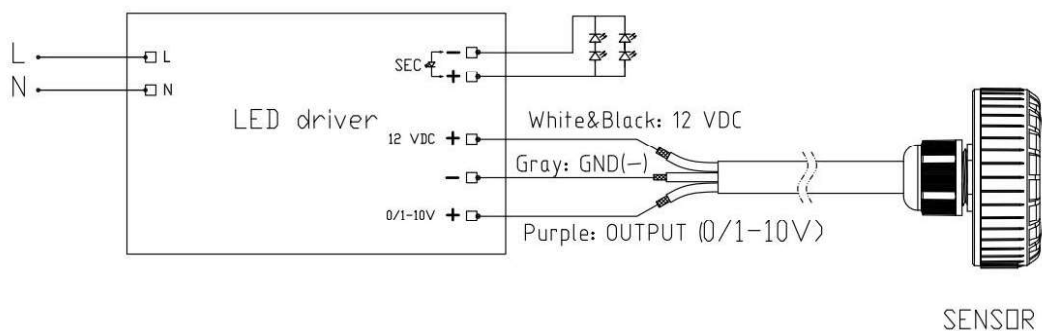

\*The sensor is designed for connect one load only. Connect more than one loads may damage the sensor.

## 6. Structure

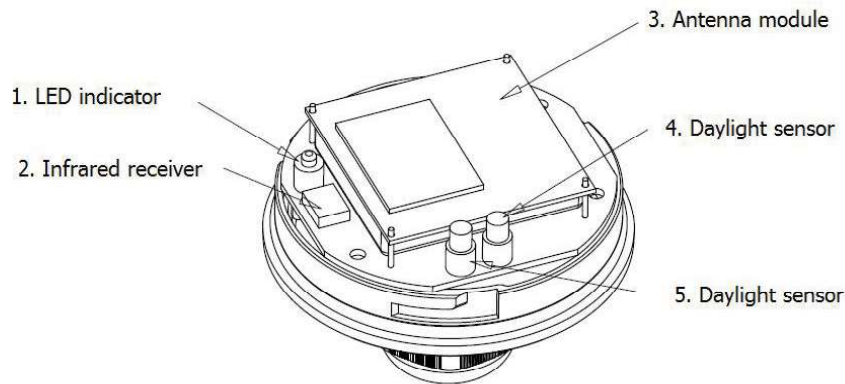

## 7. Radiation Pattern

### Ceiling mounting

Ceiling mounted height: 3m  
Sensitivity: 100%/75%/50%/25%

Ceiling mounted height: 12m  
Sensitivity: 100%/75%/50%/25%

Ceiling mounted height: 15m (\*)  
Sensitivity: 100%/75%/50%

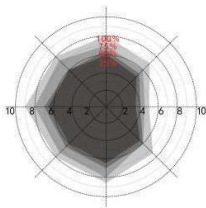

Normal moving (Speed:1m/s)

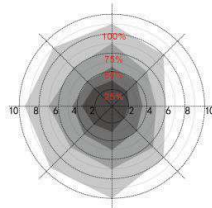

Normal moving (Speed:1m/s)

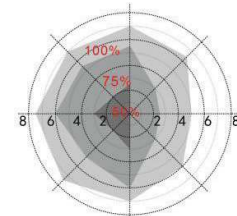

Normal moving (Speed:1m/s)

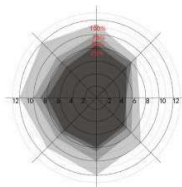

Slow moving (Speed 0.3m/s)

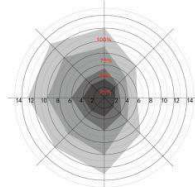

Slow moving (Speed 0.3m/s)

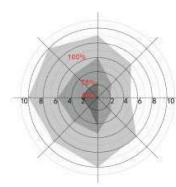

Slow moving (Speed 0.3m/s)

Only 100%/75%/50% detection sensitivity is workable when installed at 15m mounting height. 25% sensitivity is not able to detect motion signal.

## Wall mounting

Horizon mounted height: 2m  
Sensitivity: 100%/75%/50%/25%

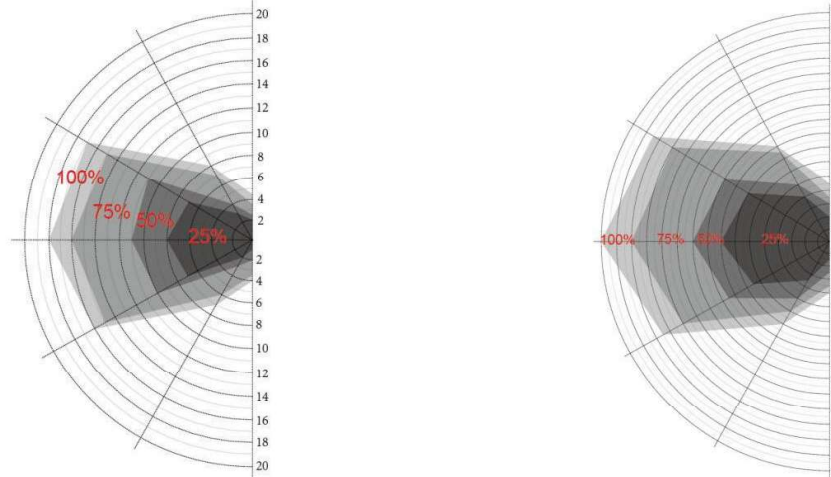

## 8. Initialization

1) On/Off function /3-step dimming function:

After power on, the sensor automatically turns on light at the initialization, the sensor is not able to detect movement.

2) 2-step dimming function:

After power on, the sensor automatically turns on light at 100% brightness. After 10sec, it dims the light to a low light level (set by stand-by dim level). During the initialization, the sensor is not able to detect movement.

## 9. Factory Setting

Detection area: 100%, Hold Time: 5S, Stand-by Period: 0s, Stand-by dim level: 10%, Daylight Sensor: Disable

## 10. Application Notice

1) The sensor should be installed by a professional electrician. Please turn off the power before installing, wiring, changing the setting of the DIP switch.

2) The sensor which installed in the plastic and glass lampshade will reduce the sensitivity. For every 3mm increase in thickness, the sensitivity will be reduced by 20%.

3) The dimming performance could be different from different 0-10v drivers.

4) The light sensitivity threshold is in a sunny environment, no shadow and ambient

light diffuse reflection. Ambient lux level could be different in different environment, weather, climate, time-of-day and season.

- 5) The parameters of the sensor may need to be reconfigured in different installation environments. Please refer to the following instructions or contact the manufacturer.
- 6) This sensor is for indoor use only. It will affect the waterproof effect for outdoor use. Wind, rain, and moving objects around will cause false triggering.
- 7) The distance between any inductive sensors should be greater than 3m.
- 8) Do not place the sensor close to high-density objects such as metal, glass, concrete walls, etc, false triggering could happen. When the sensor is installed in a metal lamp, metal reflective surface, or a narrow enclosed environment, the microwave will be reflected repeatedly and cause false triggering. Please reduce the sensitivity or contact the manufacturer for technical support.
- 9) Please ensure that there are no moving signals around the sensor, such as fan, DC motor, sewer pipe, air outlet, etc., the sensor may generate false trigger.
- 10) You are advised to test 5 samples before mass application of sensor in a new lighting project.
- 11) Due to continuous improvement, the contents of this instruction could be changed without prior notice